







COD.	 cm	"A"	"B"	 Kg	 n°	finiture profili profiles finishings acabados de perfil acabamentos de perfil		finiture vetro - glass finishings acabados de vidro - acabamentos de vidro		
						L	R	P (€)		T (€)
Naif R2S / 80 NFR2S080/ _	77 - 79,5	46	30	38	1	L	R			
Naif R2S / 90 NFR2S090/ _	87 - 89,5	46	40	39	1	L	R			

** ordinando il box in bianco RAL 9010 cerniere, maniglie e piccoli componenti rimarranno argento lucido
** with the white RAL9010 finishing hinges, handles and other components remains silver shining
** si se pide la cabina en blanco RAL 9010, las bisagras, los tiradores y los componentes pequeños son de todas maneras plata brillante.
** com dobradiças em acabamentos Branco RAL9010, puxador e outros componentes mantem cromado brilho

Profili di compensazione allunga di 2 cm - Adjustment profile of 2 cm
Perfil compensador prolongación 2 cm - Perfis de compensação 2 cm

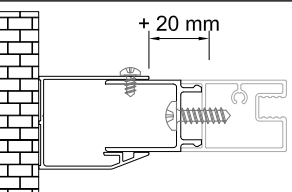
	COD.	(€)	
	PMOR017/ _	L	•
		R	•

Disegni tecnici - Technical drawings
Dibujos técnicos - Desenhos técnicos

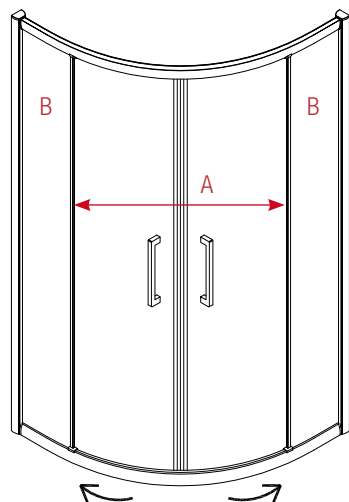

Profili a muro - Wall profile
Perfil de pared - Perfil de parede

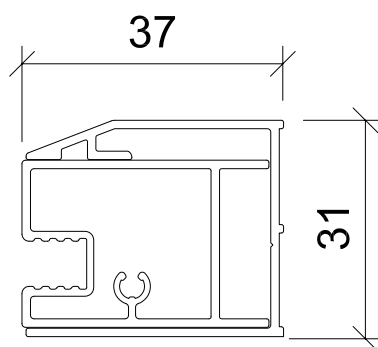

Materiali e finiture - Materials and finishings
Materiales y acabados - Materiais e acabamentos

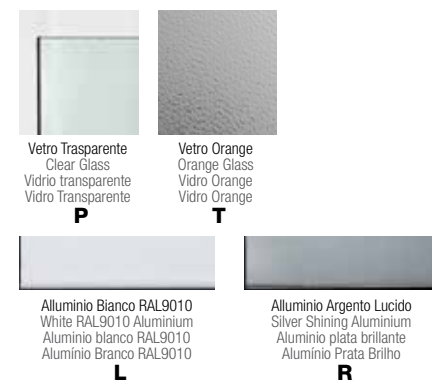

Caratteristiche tecniche - Technical features
Características técnicas - Características técnicas

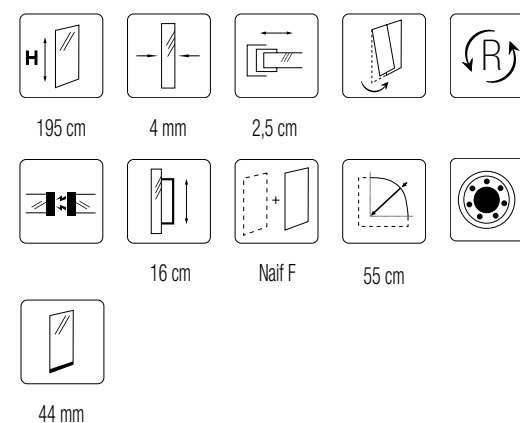

PROTECTIVE ●●●		
P → F	6 → W	8 → J
L → I	7 → C	T → 5
B → S	X → Q	B → S
K → N	O → H	6 → W
X → Q	9 → V	7 → C

